

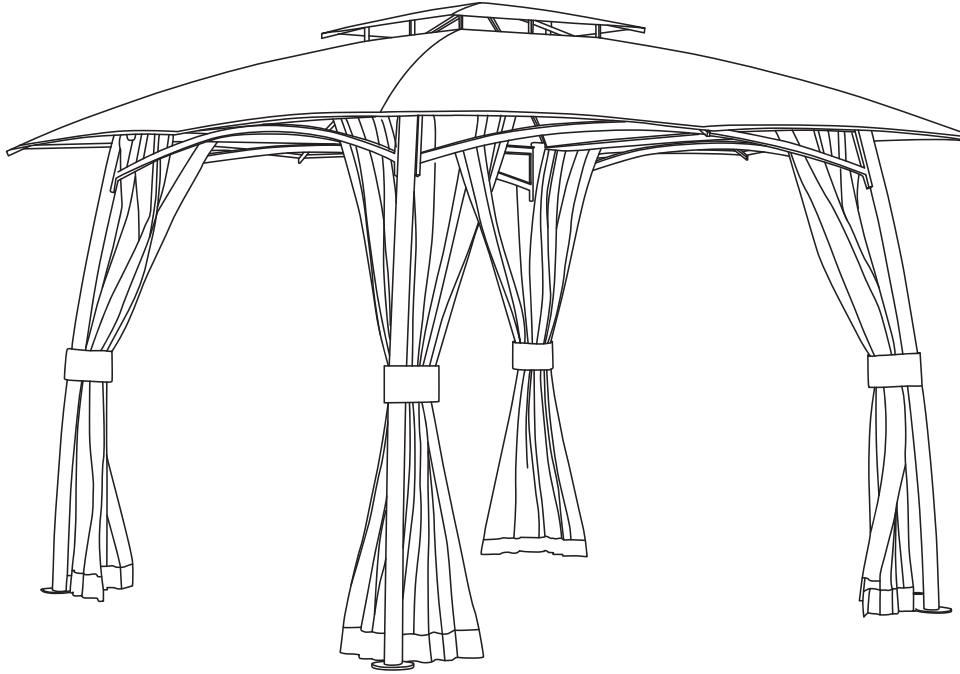











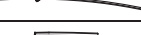

ASSEMBLY INSTRUCTIONS



READ & SAVE BELOW INSTRUCTIONS BEFORE ASSEMBLY

1. PLEASE SEPARATE AND IDENTIFY ALL PARTS, MAKING SURE THAT YOU HAVE ALL OF THE PARTS LISTED.
2. TO AVOID ANY SCRATCH DURING ASSEMBLY, PLEASE ASSEMBLE ON A SOFT MAT OR SIMILAR.
3. PLEASE ASSEMBLE STEP BY STEP AND FOLLOW THE INSTRUCTIONS.
4. WASHERS MUST BE USED.
5. WHILE EACH SCREW AND NUT IS PROPERLY FASTENED, DO NOT OVER FASTEN IT.
6. DO NOT COMPLETELY FASTEN EACH SCREW AND NUT UNTIL ALL THE SCREWS ARE PROPERLY FIXED.

| PARTS LIST | | |
|------------|---|------|
| CODE | PARTS | QTY. |
| A |  | 4PCS |
| B |  | 4PCS |
| C |  | 4PCS |
| D |  | 4PCS |
| E |  | 4PCS |
| F |  | 4PCS |
| G |  | 1PC |
| H |  | 1PC |
| I |  | 4PCS |
| J |  | 4PCS |
| K |  | 1PC |
| L |  | 4PCS |

| HARDWARE LIST | | |
|---------------|---|------|
| CODE | PARTS | QTY. |
| M |  | 8PCS |
| N |  | 8PCS |
| O |  | 1PC |

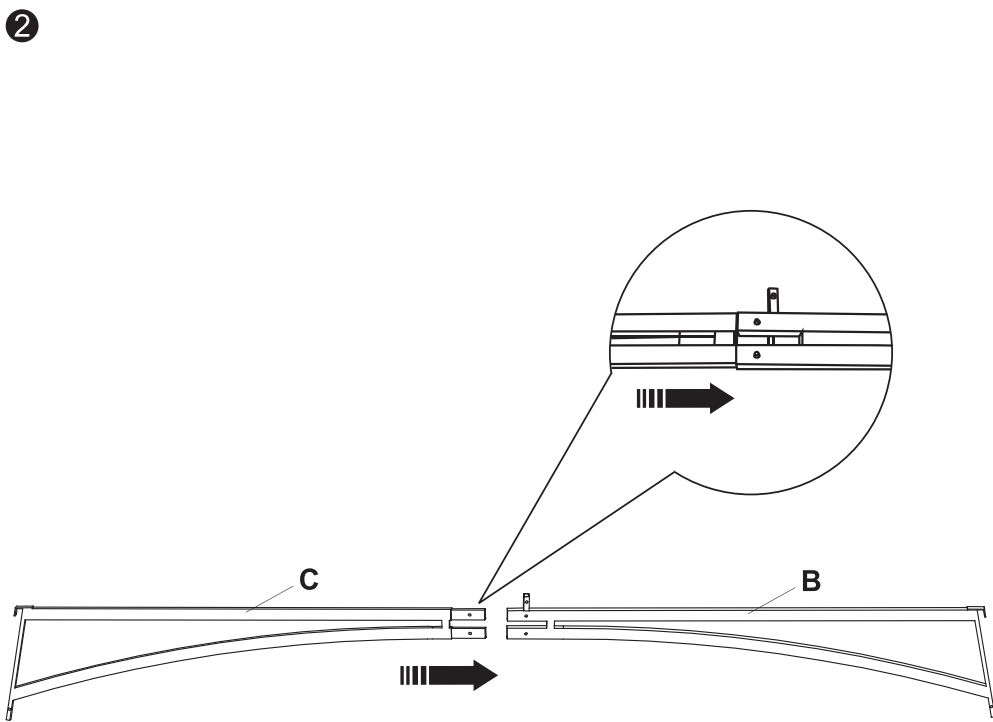
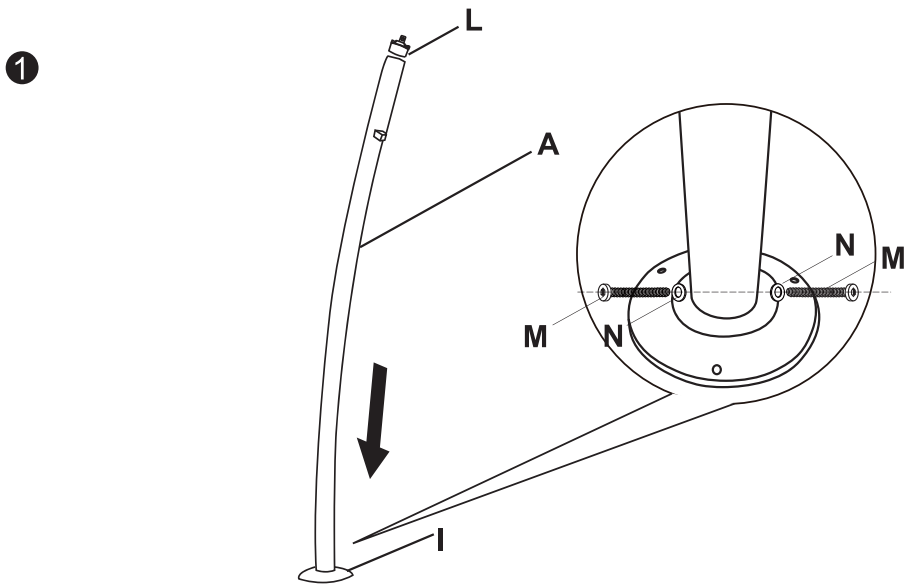

3

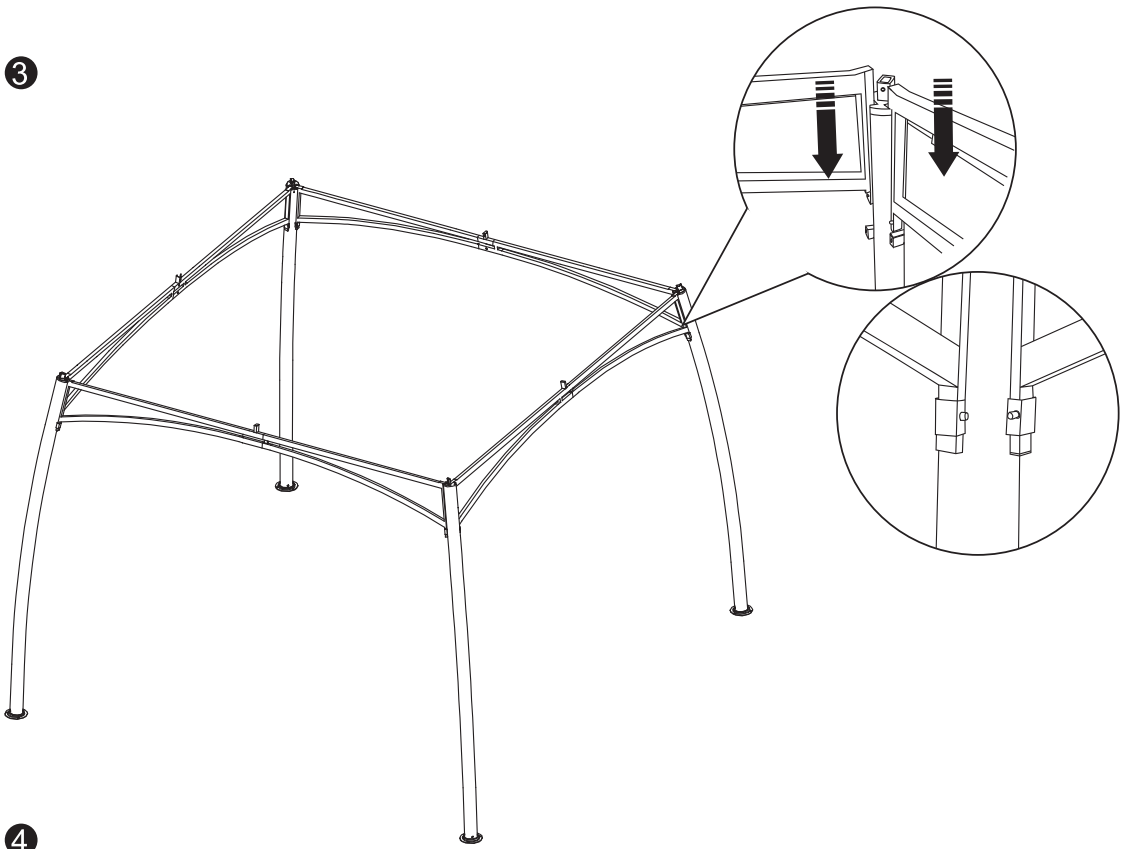

4

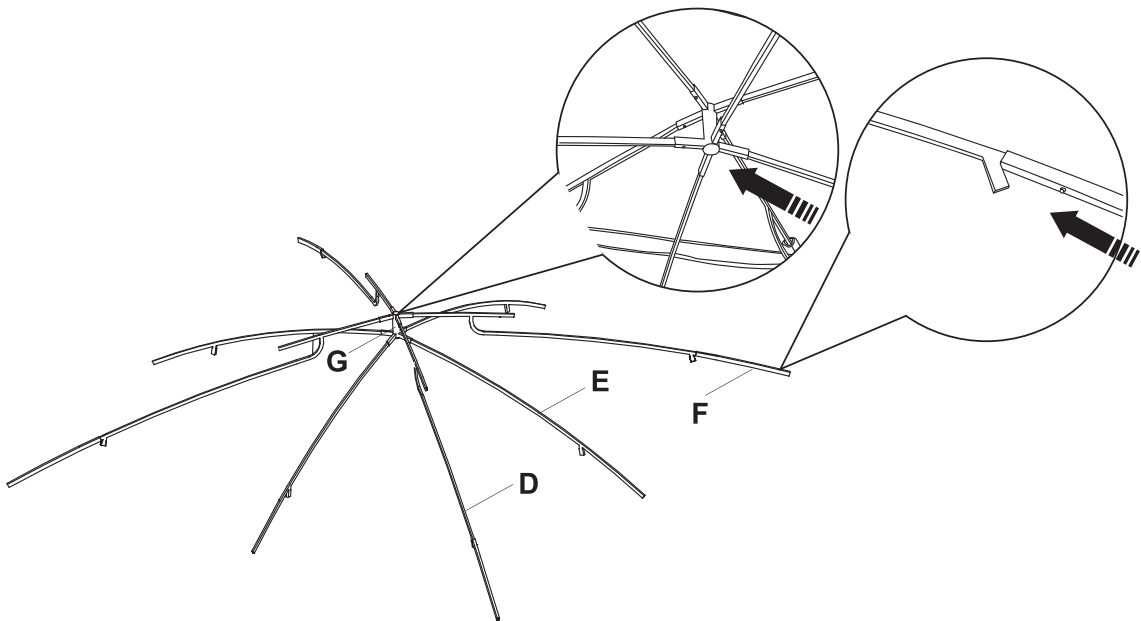

5

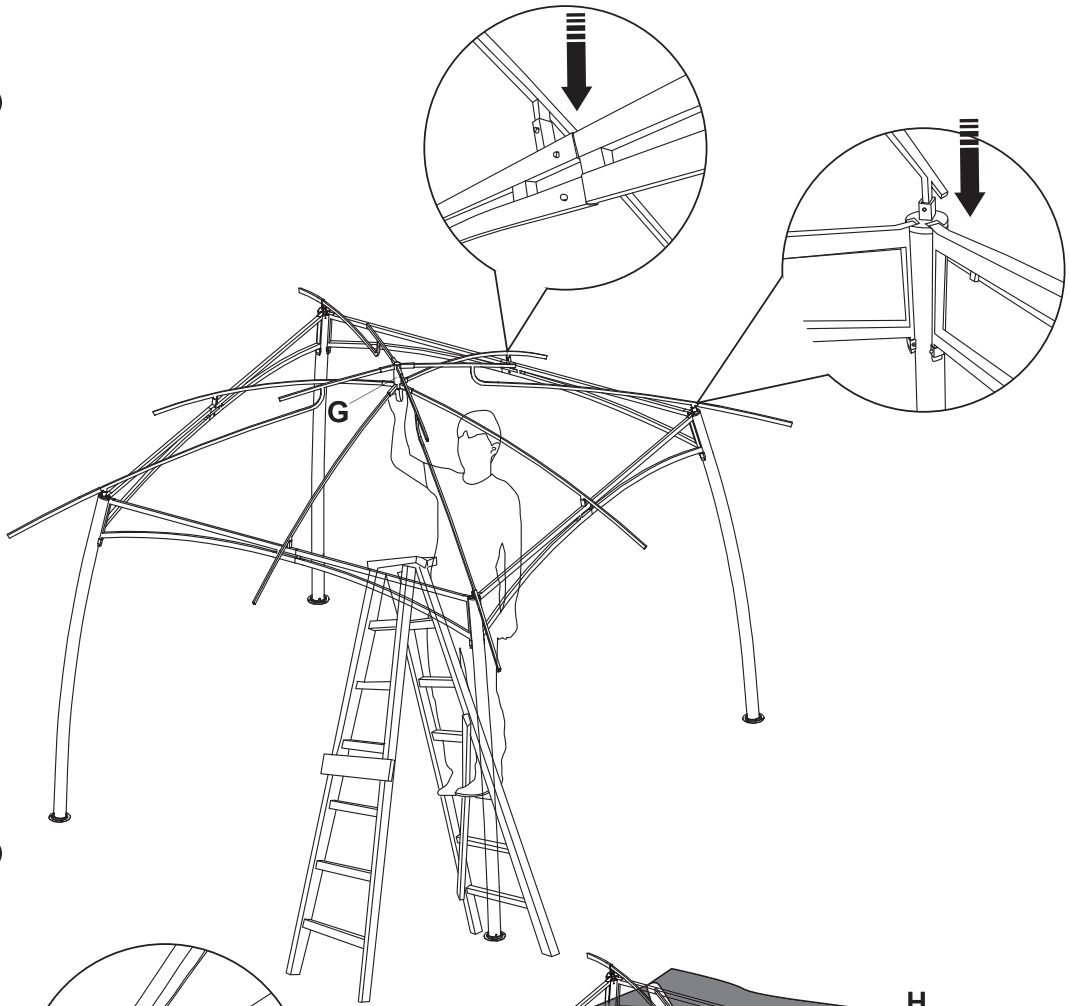

6

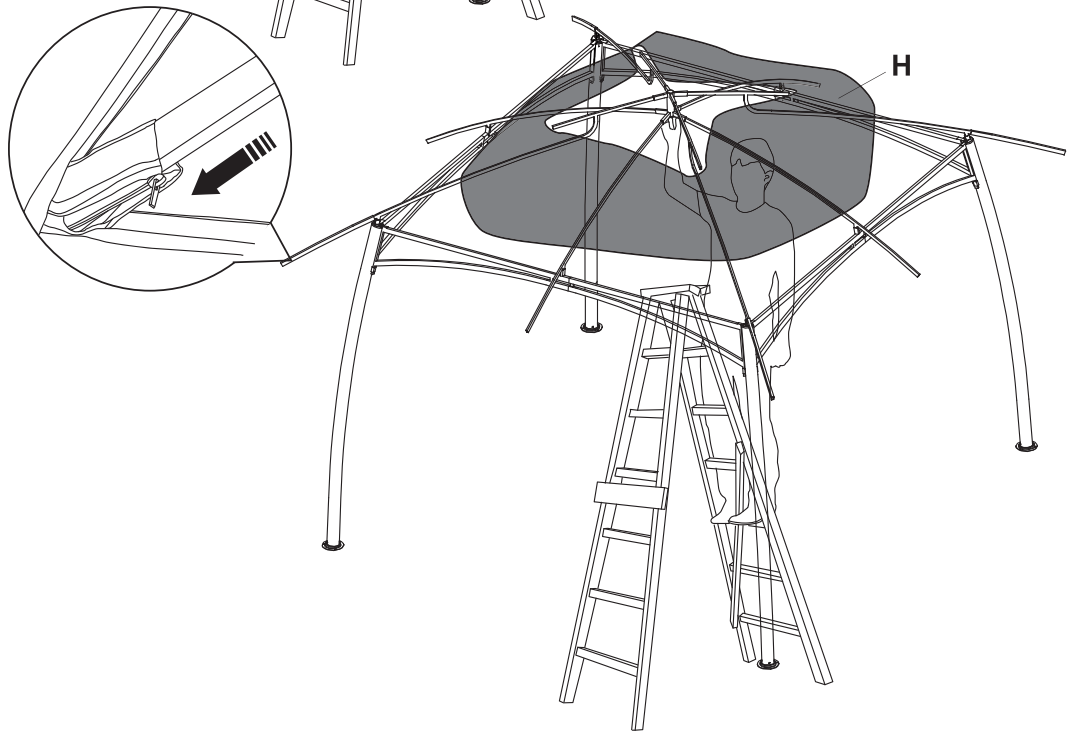

7

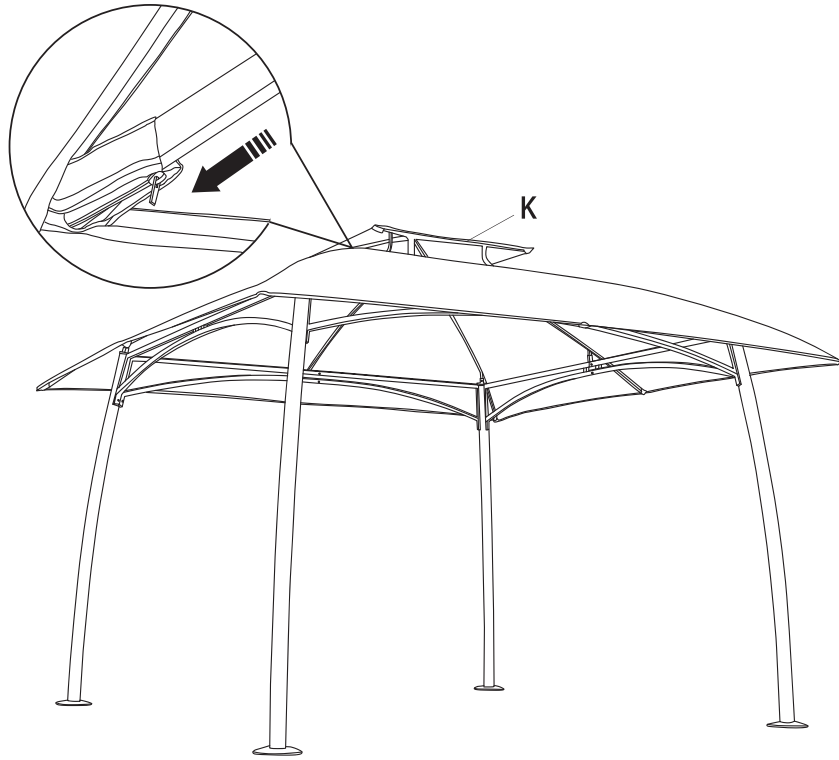

8



9

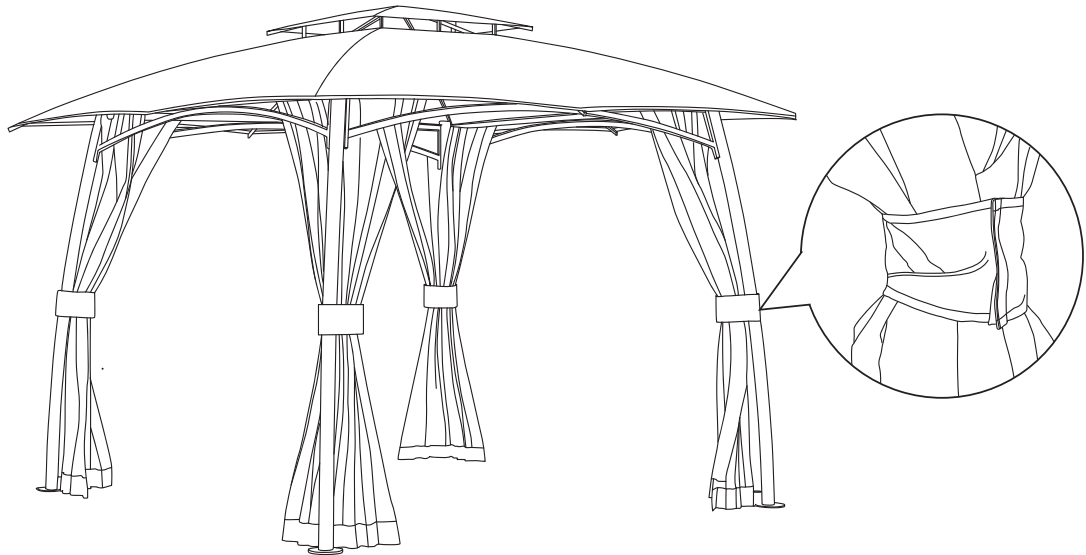

CARE AND CLEANING:

Gefeliciteerd met uw aankoop van dit VAN CRANENBROEK tuinmeubel.

Bescherming en onderhoud :

Gebruik een vochtige doek om te kuisen. Gebruik geen bleekmiddel, noch zuur oplosmiddel, noch schuurmiddel op het metalen frame. Indien door krassen metaal blootgesteld wordt, alsook aan soldeerpunten, raden wij aan direct te behandelen met roest afstotend of gelijkaardig product. Controleer op regelmatige basis.

Gelieve tijdens winterperiode je meubelen droog en beschermd op te bergen.

VAN CRANENBROEK is niet aansprakelijk voor schade die veroorzaakt wordt door slechte weersomstandigheden, afwijkend gebruik, of het niet respecteren van instructies.

VAN CRANENBROEK wenst je veel plezier met je aankoop!

Félicitations avec votre achat du meuble jardin VAN CRANENBROEK.

Protection et entretien :

Pour le nettoyage, utilisez un chiffon humide. N'utilisez pas d'eau de javel ou de solvant acide, ni de nettoyant abrasif sur le cadre en métal. Si le métal ou les points de soudure sont endommagés, nous recommandons de traiter le métal directement avec un produit antirouille. Contrôlez-le régulièrement.

Pendant l'hiver, nous vous conseillons de ranger vos meubles de jardin à un endroit sec et bien protégé.

VAN CRANENBROEK ne peut pas être responsable des dommages suite aux conditions météorologiques extrêmes, utilisation extrême, ou de ne pas respecter les instructions.

VAN CRANENBROEK vous souhaite beaucoup de plaisir avec votre achat